



Harmony Bath Lift User Manual



Harmony Wellness Group Ltd.

#5 – 740 Huronia Road, Barrie, Ontario, L9X 0J4, Canada

Tel: (800) 265-9615 | www.Harmonyproducts.com | Info@Harmonyproducts.com

2023.02

Table of Contents

1.0 Product Introduction	Pg. 2
2.0 Items Before Use	Pg. 3
2.1 Operation Before Use	Pg. 3
2.2 Warnings	Pg. 3
3.0 Charging and Storage	Pg. 3
4.0 Installation and Usage	Pg. 5
5.0 Maintenance	Pg. 9
6.0 Appendix	Pg. 10
(a) Technical Specifications	Pg. 10
(b) Troubleshooting	Pg. 11
(c) Warranty and Disclaimer	Pg. 12

1. Product description

The Harmony bath lift is designed to assist users with limited mobility to enter and exit the bathtub more easily and conveniently at home, making bathing easier, safer and more enjoyable.

The Harmony bath lift is compact in structure and foldable and can be easily stored and transported.

The Harmony bath lift is designed to be used with common bathtub sizes, so it can be easily positioned in any standard bathtub (some non-standard or specially customized bathtubs may not be suitable).

The Harmony bath lift is equipped with 6 suction cups at the bottom, which makes it more stable and has a good anti-slip effect.

The Harmony bath lift is completely powered by batteries and is not required to be plugged into a power source during use. The bath lift is completely waterproof, except for the charger.

The Harmony bath lift uses a modular design, meaning the back and the seat can be folded and/or disassembled. The backrest is automatically locked to the seat base when the bath lift is raised, which prevents the back of the chair from folding unintentionally. Our protection control ensures the hand control can lower the bath lift when the power is insufficient.

In this user manual, you will get all the information about the Harmony bath lift, including installation, usage, storage, etc.



2. Items before use

2.1 Operation before use

1. Before your first use, please read all instructions carefully to become familiar with the bath lift and its operation.
2. Please keep these instructions for others who may operate or use the bath lift
3. First, evaluate the user to ensure that the bath lift is suitable. The evaluation items include but are not limited to the user's weight, volume, cognitive ability, joint mobility, etc. Please do not allow the bath lift to be used by people who are not familiar with its' operation. When a person with a disability uses the device, there must be an attendant or an alarm device nearby;
4. Use it in a standard bathtub that suits the capabilities of the lift and ask an assistant or professional to determine whether the use environment meets the capabilities.
5. Before each use, please check that the suction cups and seat surface are clean, *remove* stains and adsorbents, check and conduct a trial operation to ensure all parts of the lift are present and functioning. Verify the emergency stop button works;
6. If you use bath oil, bath salts and other toiletries, you need to prevent high concentrations of toiletries from damaging the structure and sliding function of the bath lift;
7. When using, the user should sit down slowly and calmly to avoid excessive stimulation and damage to the bath lift or personnel;
8. Please use the provided hand control to operate;
9. Please install the bath lift according to the installation instructions provided in this manual.

2.2 WARNINGS

1. Do not overload;
2. Do not stand or kneel on the bath lift;
3. During use, do not sit on the opposite side;
4. Do not use on heavily sloped surfaces (*over 5°*) or surfaces with step;
5. Do not use if parts are missing;
6. Do not use for other purposes other than bathing;
7. Do not leave children unattended while using;
8. During maintenance and use, do not put hands, feet and other body parts or objects into moving parts;
9. Do not place toiletries (such as toothbrushes, razors, etc.) near the cross structure.
10. Do not place the hand control near heat sources;
11. During lifting and lowering of the bath lift, do not put body parts such as hands, feet, and other items into the moving parts;
12. Do not modify this device.

3. Charging and Storage

1. Please use the matching charger to charge;
2. The optimal capacity of the battery may be reached after a few charging cycles;
3. When charging, keep away from water, heat, etc.;
4. The hand control comes standard with three-color indicator lights. In normal use, the green light indicates that the power is sufficient, the blue light indicates that the power is insufficient, and reminds to charge. When the red light is on, it indicates that the power is seriously insufficient and needs to be charged immediately to prevent sudden power loss during operation;
5. Under normal charging conditions, the indicator light of the charger is red, and when the battery is fully charged, the indicator light of the charger is green, and the charging time is approximately 2.5 hours;
6. The charger is designed for charging the hand control and cannot be used for other purposes;
7. The battery is built into the hand control, please do not disassemble the hand control without instruction; when the bath chair is being transported, please confirm that the wires are disconnected and are not in charging mode; Prevent damage to the bath lift and personnel caused by falling, collision, etc.
8. In the process of cleaning the hand control or the charger, please make sure that the plugs are disconnected; the charger can only be cleaned with a dry cloth;
9. Although the hand control and charger are reliable designs, they still cannot withstand the risk of falling; if you find some signs of damage on the surface of the hand control and charger, please contact your authorized dealer immediately for required service;
10. Please sit in the middle of the seat of the bath lift, lean back on the back of the chair, stretch your legs forward, put one hand on the side panels, or on your lap, and operate the hand control with your free hand;

11. Our bath chair has passed the EMC test. When you use other electrical appliances in the bathroom or use a mobile phone, please try not to lift the bath lift at the same time to prevent electromagnetic interference the may affect regular operation. If the bath lift is not functioning properly, please contact your dealer for assistance.

• **Please carefully read the following important information about the hand control (rechargeable lithium ion battery)**

It must be charged before the first use

Since lithium-ion batteries must not exceed 30% of their nominal capacity during transport, they must be charged for at least 12 hours before first use.

It is recommended to keep the battery power at 40-60% when storing

When not in use for a long time, the hand control needs to be disconnected from the unit and stored in an environment with low temperature, low humidity, no dust and no corrosive gas to maintain the best performance when the battery is used subsequently.

The following table shows the recommended storage time under the corresponding storage environment. After the storage time is exceeded, the battery should be put into use.

Storage time	Storage environment
1 year	10-25°C (1*), 40 - 70% RH (non-condensing)
3 months	0-35°C (1*), 30 - 75% RH (non-condensing)
1 month	-10~50°C (1*), 20 ~ 80% RH (non-condensing)

It must be charged and discharged once within 6 months of receipt; during storage, the hand control (battery) must be charged and discharged once every 6 months.

Rechargeable batteries are considered a consumable that has a limited life span and may to degrade in performance. Normal battery wear and tear is not included in returns and warranty claims. Harmony offers a one-year warranty on its battery products.

• **Charging process**

- (1) Disconnect the hand control from the bath lift.
- (2) Ensure that the connection parts and the charger are sufficiently dry.
- (3) Plug the female plug of the hand control into the male plug of the charger.
- (4) Plug the charger into a suitable outlet. Charging voltage range: 100-240VAC.
- (5) When charging is finished, please disconnect the charger immediately to avoid affecting the battery life.

4.0 Installation and usage

- Installation and use environment confirmation

Please check the parts for damage and defects before use. Only use it if you are sure that there are no damaged or missing parts.

As shown below:



Parts included

Hand control®

Charger

Backrest (including linear actuator and backpad)

Base (cushion and 6 suction cups)

Instruction manual

(1) When receiving the bath lift and then opening the package, please first read the instruction manual.

(2) Please take out the back part of the chair and the seat part and install the back to the seat.

(3) You can See the following figure for details.

Align the backrest hook with the base guide bar.

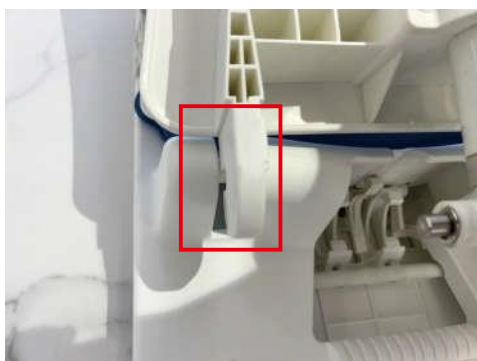

Press the hooks on each side of the backrest to connect them to the base.

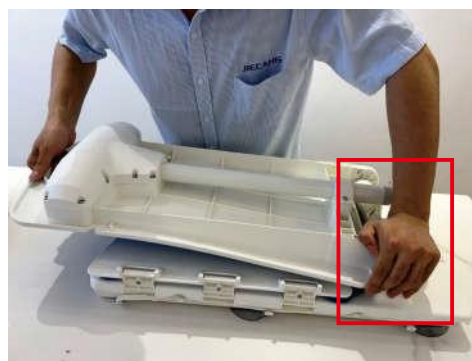

Complete the installation of the backrest and the base.

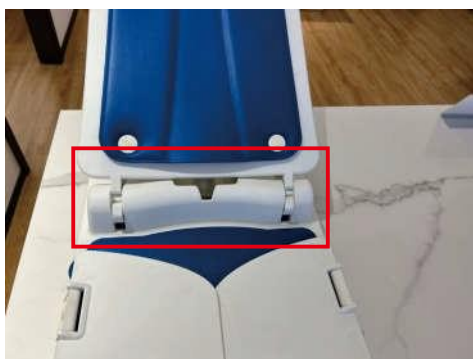

Make sure the top clevis of the actuator is connected correctly with the base hook lock.



CORRECT .J

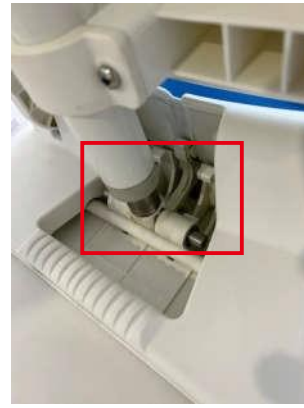

WRONG x

- (4) Please check whether the 6 suction cups at the bottom of the seat have loosened during transportation or movement. If they are loose, tighten the suction cups.
- (5) Confirm that there are no obstacles or objects in the bathtub that may cause the unit to tip over or affect the normal lift of the bath lift, including shower heads, faucets, fittings, etc..
- (6) Position the bath lift in the bathtub and ask for assistance if you have difficulty.
- (7) Please ensure that the floor is dry and free of obstructions to prevent slipping or other accidents during the handling or placement of the bath lift.
- (8) In the process of putting the bath lift into the bathtub, please make sure that there is enough between the bathtub and the back of the bath lift. Prevent the bath lift from hitting the bathtub or other objects in the bathroom. Also confirm that there are no relevant obstacles (including but not limited to faucets, shower heads, etc.) within the range of the bath lift.
- (9) Make sure that the 6 suction cups are in full contact with the bottom surface of the bathtub.
- (10) Please make sure that the male plug of the bath lift and the female plug of the hand control are completely dry before connecting them to each other.
- (11) Place the hand control wire on the outside of the bath lift to prevent the hand control line from being pressed or pulled apart, causing damage or a poor connection.
- (12) Make sure that the bath lift can be lifted properly and safely before each use.
- (13) Press the hand control up button to rise, press the down button to fall, the stop button has an emergency stop feature. When in the process of descending, if the user feels unsteady, press the stop button and the bath lift will not be able to descend. You need to press the up button before you press the down button again.
- (14) Textured button to assist those with visual impairments
- (15) The hand control is in jog control mode, i.e. the button is valid when pressed and invalid when released.
- (16) When the bathing chair is stored at a lower temperature (e.g. in winter), if it needs to be used again, allow it to warm up naturally to room temperature before use.;
- (17) After each bath, it is recommended to wash the bath chair with water and let it dry naturally.

Hand control

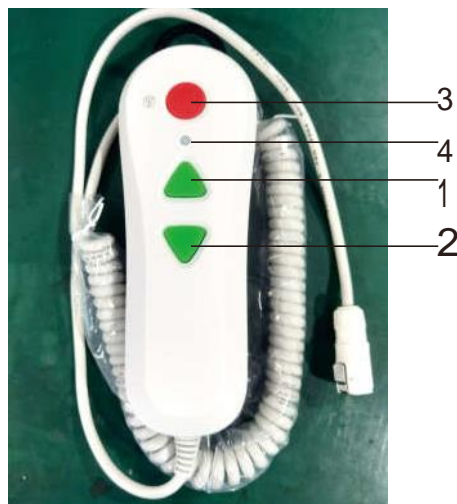

1. Upper triangle button: Up button - controls the rise of the bath chair
2. Lower triangular button: Down button - controls the descent of the bath chair
3. Round button: Emergency stop button - control the bath chair emergency stop, and no longer descend, if you need to descend need to first press the up button and then press the down piece to descend
4. Indicator light: shows the working status of the shower chair

• **Start use**

- (1) First, please open the back of the bath lift, and plug the hand control with the female plug on the back.

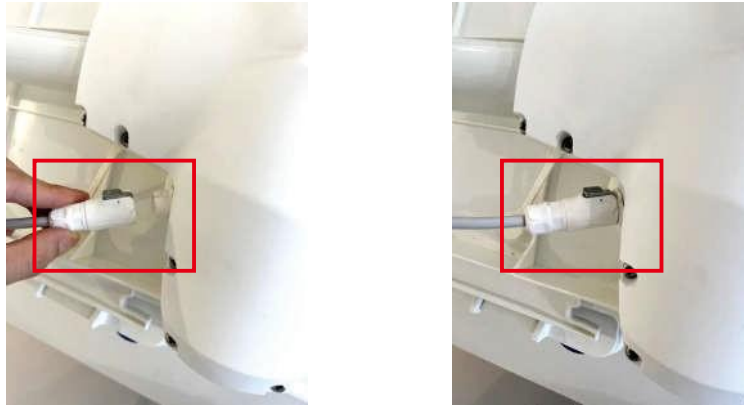

- (2) Let the bath lift rise until the sides of the side plate lean smoothly against both sides of the bathtub;
- (3) With your back to the bathtub, sit on the outside side plate;
- (4) Maintain the above position and move the hips to the middle of the seat of the bath lift;
- (5) Put both feet into the bathtub;
- (6) Once you are in the bathtub comfortably, use the hand control down button to drop the bath lift to your desired position. Keep hands and feet safe during the descent;
- (7) If the down button is pressed, the bath lift will stop at the lowest point;
- (8) If conditions permit, have the user operate the hand control rather than the assistant. This will make the user feel more comfortable and will help them feel more stable and in control;

• **Storage**

- (1) The user leaves the bath and waits for the water to drain from the bath before lowering the bath chair to its lowest point and folding up the back of the chair;
- (2) Before picking up the bath lift, make the suction cups inflate by lifting the armrests. Balance the pressure difference between suction cups and atmospheric pressure to lift the bath lift easily;



- (3) Wash the bathing chair equipment with water to remove foam, stains, etc. (keep the hand control linked to the bathing chair's plug).
- (4) Disconnect the hand control from the bathing chair and wipe it clean with a dry cloth.
- (5) Store the bath chair and hand controls.

- **Carrying**

Lift the back and base sections separately



Lifting of the whole machine



- **Emergency Stop**





- (1) Press the stop button for emergency stop when the bath lift does not stop normally;
- (2) If the emergency stop button is pressed during the descent, the down button function will be locked, and the down button will resume its effect only after the rise (up) button is pressed;

- **Environmental impact on equipment**

- (1) Avoid direct sunlight to avoid material aging
- (2) Keep away from fire source (high temperature) to avoid lithium battery explosion and material aging and deformation

Keep the charger away from places with high humidity to avoid short circuiting of the adapter

- **Symbol explanation**

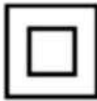
Symbol	Description
	Warning
	BF type application section
CE	CE certificate symbol
	You can't put it in the bin, it has to be professionally recycled
	Indoor use
IP68	Dustproof class 6, waterproof class 8
	Category II equipment

5.0 Maintenance

- (1) After the bath is finished, please rinse the bath lift with warm water. If the bath lift is dirty, you can clean it with a cloth, brush, etc. and then dry it with a cloth
- (2) Do not clean the hand control (part 1) and actuator (part 2) with detergent or disinfectant. If necessary, scrub with a cloth dampened with a small amount of water. Do not immerse the hand control and actuator in water ;
- (3) Do not use high-concentration disinfectant to clean the bath lift;
- (4) When cleaning the lower part of the seat, pay attention to lifting the scissors to prevent hand clamping;
- (5) When different users use it, please clean it thoroughly;
- (6) Make sure the bath lift is fully dry before storing;
- (7) If possible, ask someone to clean and maintain it;
- (8) The charger must be unplugged from the power plug before cleaning;
- (9) Please do not rinse the charger with water, please clean it with a dry cloth;
- (10) Each bath lift is used by a single person. After each use, it is necessary to wipe off the water droplets with a dry cloth, then dry in a ventilated place, and finally store it in box. Every three months, use 75% medical alcohol to disinfect the bath lift. Wipe the surface of the bath lift, disinfect the bath lift, dry it in a ventilated place for 1 hour after disinfection, and finally store it in the box;
- (11) Bath lift must be inspected or repaired by an authorized dealer every 12 months.

6.0 Appendix

a. Technical Specifications

Operating temperature	5-40°C
Operating humidity	Under 30°C 20%-90%
Operating air pressure	700-1060 hPa
Operating altitude	≤2000m
Storage temperature	-10-50°C
Storage humidity	20%-90%
Storage air pressure	700-1060 hPa
Charging voltage	100-240V 50/60Hz max0.8A
Battery pack	14.8V 2.2Ah
Specified load	1400N
Lowest point height	60.5mm±5mm
Highest point height	482.5mm±5mm
IP grade	IP68

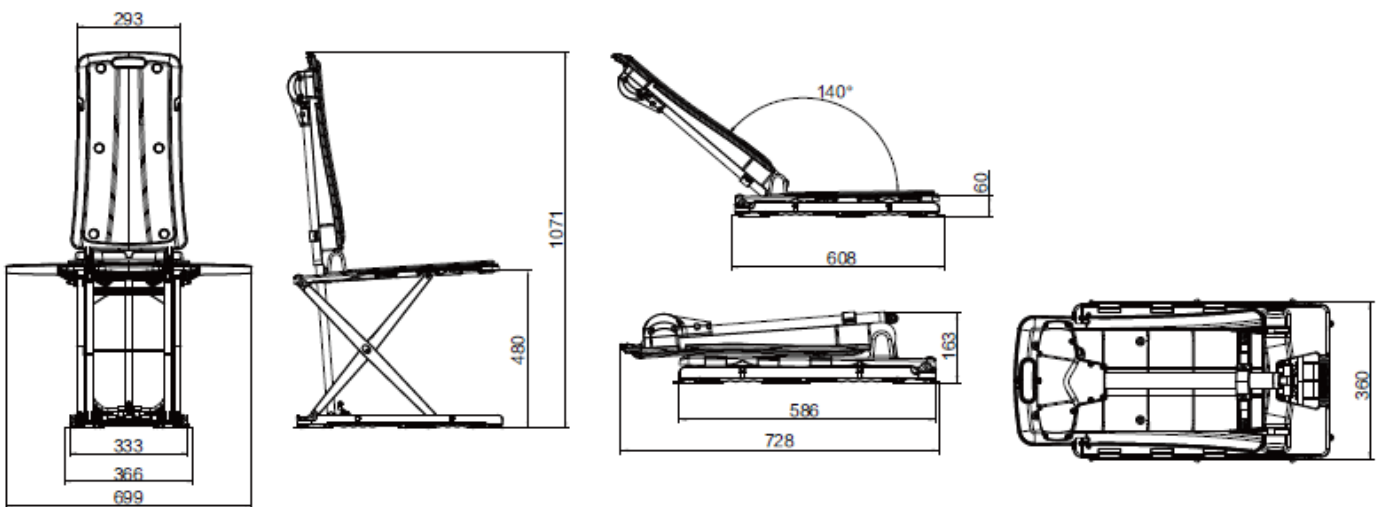

All measurements shown in millimeters

b. Troubleshooting

- i. Will not lift without load. It may be the actuator worm gear pulling teeth. Listen to the sound. If the motor rotates but cannot rise or fall, it can indicate that the actuator worm wheel is pulling teeth; if there is no sound, the internal transmission structure may be blocked or there is water inside, if the above situation occurs, please contact your dealer.
- ii. If the bath lift is unstable in the bathtub, check whether the suction cup has made sufficient contact with the bathtub.
 - c. If the user is not sitting on the bath lift, it can operate normally. If the user is sitting on the lift, the chair will not rise. Whether the user exceeds the load requirement of the manual, the operator enters the overcurrent protection.
 - d. The entire bath lift will not go up and down when it is empty. Whether the operator hears a buzzer alarm sound, if there is an alarm sound, it means that the operator has insufficient charge and needs to be charged in time. If there is no response, please contact your dealer.

c. Warranty and Disclaimer

This product (excluding hand controls and consumables) warranty period of 36 months after the sale (only for home or personal use). The expected service life of this product is 5 years. In the following cases, this warranty will be null and void. Customer should take the responsibility of the resulting accidents;

- i. Exceed the warranty period
- ii. Not used in accordance with the product technical parameters and installation.
- iii. User removes or modifies the product privately
- iv. Warranty label is damaged
- v. Suction cups and chair cushions are consumable products, they are not included in the scope of the warranty
- vi. For non-human causes of damage, the company will be discretionary
- vii. Improperly climbing in and out of the bath lift causing the shower chair overturned, resulting in damage to the shower chair, or personal injury of the user.
- viii. Using the bath lift as a standing, lifting equipment, or similar applications
- ix. Arbitrarily allowing animals and children near to the running bathing chair and causing injury.
- x. Private repair and modification of the bath lift equipment (hand control, charger, chair frame, chair seat, etc.).
- xi. Operating the bath lift with known damage, which causes secondary damage to the product, even in the event of personal injury.
- xii. The use of accessories other than those in the package, such as the private use of adapters, mismatched chargers, other hand controls, etc.
- xiii. Bath lift stored near the source of fire or heat, resulting in the loss of some functions.;
- xiv. Excessive use of bath oil or bath salts and other bathing products which accelerates the aging of the chair frame structure.
- xv. The use of acidic detergents, cleaning agents, disinfectants, and other cleaning products.
- xvi. Put hand control, the charger at charging or non-charging state near fire and heat sources, and cause damage to the equipment
- xvii. Inserting conductive materials into the control and charger socket (such as metal parts), thus causing safety hazards.
- xviii. In the process of rising and falling, please do not put your hands on the edge of the seat or below to prevent injury.
- xix. Warranty is not valid for resale or gifting
- xx. Warranty is only for manufacturer defects, damage caused by man-made reasons and natural wear and tear are not covered by the warranty.
- xxi. If the bath lift is damaged by an unauthorized user, the warranty will be invalid. Regardless of any reason, if the bathing chair damaged related to the use of a disabled or mentally ill user, the warranty will also be invalid.
- xxii. The user or operator does not follow the requirements of the instruction manual, resulting in damage or personal safety accidents, the manufacturer and the dealer will not be held responsible.